

A large blue shape that starts as a rectangle at the top and tapers to a point at the bottom left, creating a diagonal cut across the top of the page.

Making Utility-Integrated Energy Storage a Used, Useful and Universal Resource

September 2017

DOOSAN

71 Columbia Street, Suite 300
Seattle, Washington 98104

SUMMARY

Objective signs are everywhere that the stationary energy storage market is growing up quickly. The use of distributed resources such as solar photovoltaics and electric vehicles are expanding at a rapid pace, creating technical challenges for the distribution system that will require energy storage and a new generation of software to address. This paper is intended for distribution utility managers and executives and makes the following points:

- **Utility-integrated** (as opposed to merely grid-connected) energy storage projects represent a distinct, new wave of industry growth that is just getting underway and is required to manage distributed energy resources moving forward.
- Utilities and the energy storage industry have important roles to lower risk in adopting this technology – thereby enabling this wave of growth.
 - The industry must focus on engineering energy storage for adoption at scale – including the creation and support of software open standards –both to drive down costs and to limit technology and supplier risk for utilities.
 - Utilities need to take a program-based, rather than a project-based, approach to this resource to best balance cost and risk as they procure and implement energy storage.

By working together to drive down costs and manage risk, utilities and their suppliers can lay the energy storage foundation for a new, more digital distributed electricity system.

INTRODUCTION: THE ELECTRICITY DISTRIBUTION SYSTEM IS CHANGING

The desire for carbon reduction and the progress of two technologies (solar PV and lithium-ion batteries) is causing disruptive change to the electricity system (see Figure 1). Ever-growing levels of distributed energy resources, such as solar photovoltaic (PV) cells on the generation side and electric vehicles (EV) on the demand side, will push existing electricity networks to the limit of their current design. One early example of this occurred in the Fall of 2013 when the Hawaiian Electric Company was forced to temporarily stop issuing interconnection permits for distributed solar installations. While these distributed resources are essential to meeting carbon emissions reduction goals, they challenge the historical centralized paradigm for how to design, build and manage an electricity system. Without the proper foundation of utility-integrated energy storage and software controls, renewable energy resources will face increasing technical headwinds, and valuable carbon-free electricity will be curtailed in the name of system stability and reliability.

Figure 1. Dramatic cost reductions in solar photovoltaic (PV) cells and lithium-ion (Li-Ion) battery technologies are causing disruptive change to the electricity system. Distributed solar generation and the charging demands of electric vehicles will require new tools and approaches to distribution system management.

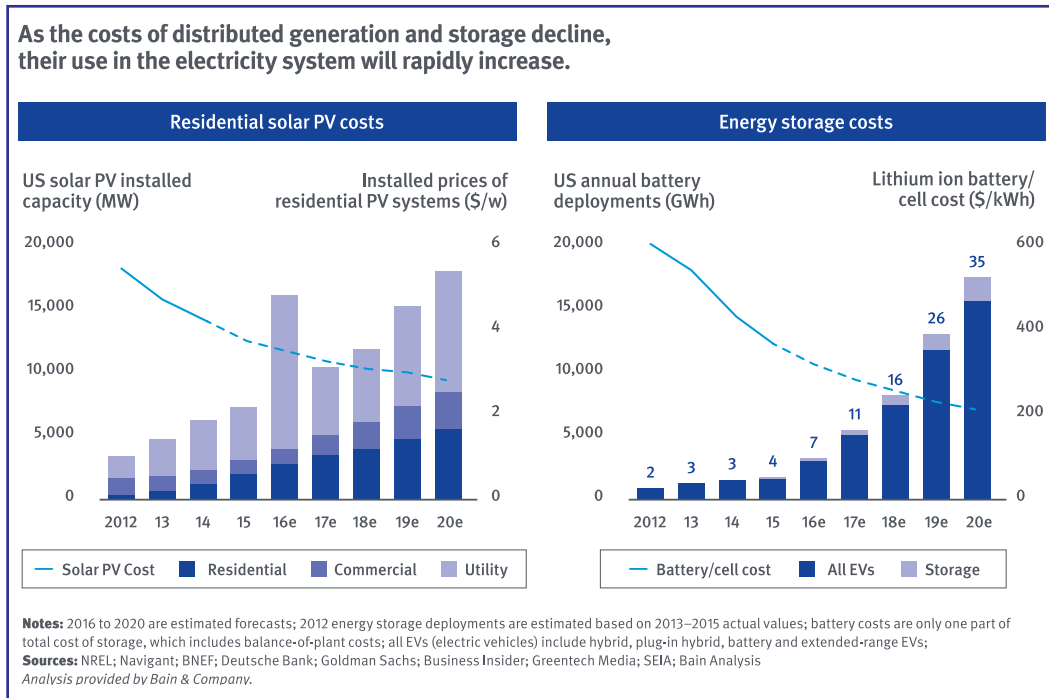

Why is energy storage so important to managing this change? Energy storage is a superset asset – no resource has more flexibility to serve as generation or load and to produce or absorb both real and reactive power. Therefore, the development of this technology is crucial to the electricity distribution system’s evolution and its ability to absorb the coming wave of distributed solar and electric vehicles. The past two decades have seen two waves of front-of-the-meter energy storage growth: the pilot wave, followed by the grid-connected wave. But the most important wave – the utility-integrated wave – is just beginning to build and more needs to be done to accelerate it by both the industry delivering the technology and the utilities adopting it.

¹The Interconnection Nightmare in Hawaii and Why It Matters to the US Residential PV Industry (<http://www.renewableenergyworld.com/articles/2014/02/the-interconnection-nightmare-in-hawaii-and-why-it-matters-to-the-u-s-residential-pv-industry.html>)

FRONT OF THE METER STORAGE: WAVES OF GROWTH AND EVOLUTION

ENERGY STORAGE WAVE 1: THE PILOT ERA

Most of the stationary energy storage work from the late 1980s through the earlier part of the 2000s can be classified as pilot projects (*see Figure 2*). The focus of these projects² was on technology development more than utility adoption, and the work was almost exclusively grant-funded. ESS designs were customized for each project with little to no thought of integrating these systems with grid operations in the future. Project success was measured by demonstrating the basic performance characteristics of the technology.

ENERGY STORAGE WAVE 2: THE GRID-CONNECTED ERA

A convenient marker of the industry's progression to its next major phase is the wave of projects made possible by the American Recovery and Reinvestment Act (ARRA). The ARRA, also known as the U.S. Government stimulus package of 2009, included funding for energy innovation projects including ESSs³. This wave of spending significantly accelerated the progress of fielded energy storage projects and enabled a next wave of growth we call the grid-connected wave (*see Figure 2*). Goals moved from exploring chemistries to specific battery applications such as renewable energy firming and ancillary services provision. Most projects were still heavily subsidized, but funding matches were required and energy storage procurement was generally driven through RFP processes.

During this period, enabled by the Federal Energy Regulatory Commission's (FERC) Orders 755 and 784, the PJM independent system operator enabled a market for unsubsidized, single-purpose, grid-connected ESSs that could provide fast-responding ancillary services for regional electric grids. As a result, PJM went from having no energy storage providing ancillary services in 2005 to 300 MW of resources participating in their market by 2016⁴. However, energy storage design in this wave remains very specialized and monolithic; and integration with distribution operations is still rare and rudimentary at best.

Grid-connected storage owners consist largely of independent power producers and merchant storage developers. Grid-connected ESSs have one or at most two use cases driving their purchase. They are designed to operate at an arms-length from the distribution system, and the owner generally wants little to no involvement in the process of operating and maintaining the system. The emphasis with these owners is generally on speed of delivery and cost. The grid-connected segment emerged early and the "Aliso Canyon" systems installed in California in late 2016 and early 2017 represent a significant maturity milestone for this wave of industry growth. One recent trend and a likely future direction is to link these systems more tightly with both traditional and renewable generation projects to take advantage of shared infrastructure costs.

² For examples of these projects, see Table 1 in Batteries for Large-Scale Stationary Electrical Energy Storage. The Electrochemical Society Interface – Fall 2010 (<http://interface.ecsdl.org/content/19/3/49.full.pdf>)

³ <http://www.sandia.gov/ess/projects/arra-funding/>

⁴ PJM leverages federal rule changes to lead country in energy storage, Southeast Energy News (<http://southeastenergynews.com/2016/11/28/pjm-leverages-federal-rule-changes-to-lead-country-in-energy-storage>)

Figure 2. The energy storage industry has grown and matured through three phases of development as depicted below from left to right.

	Pilot Wave	Grid-Connected Wave	Utility-Integrated Wave
LEAD CUSTOMER	Universities/Emerging Technology Depts	IPPs/Merchant Developers	Utility Operations
PROJECT ORIENTATION	Demonstrate battery	System capacity	Solve grid problems
DESIGN	Custom-made	Specialized	Engineered for scale
INTEGRATION LEVEL	Disconnected	SCADA-connected, manual dispatch	Integrated, automatic dispatch
SOFTWARE	Provided by hardware supplier	Decided project by project	Software architecture explicitly considered
PROCUREMENT	Grant application winners	Project-based RFPs	Program-based RFPs
PROJECT FUNDING	Grant-funded	Project specific business case/Mandated	Integrated Resource Plan
GUARANTEES	No warranties	Some warranties	Standard warranties
EXAMPLE SYSTEM	Notrees ESS	PJM F/R System	Austin Energy - Kingsbery ESS

ENERGY STORAGE WAVE 3: THE UTILITY-INTEGRATED ERA

Even as the grid-connected wave has matured, a next, perhaps even bigger wave of growth and maturity that can be referred to as the utility-integrated storage wave is building. This wave is called utility-integrated because it applies mainly to distribution utilities. These storage owners often have a very different mindset than grid-connected owners. Utility-integrated storage owners want their ESSs to serve as multi-purpose grid management tools and therefore require the energy systems to be tightly integrated with distribution operations. It is probably not surprising that these owners have a desire to be more involved in the details of the ESS delivery, commissioning, operations, maintenance and subsequent optimization over time.

The utility-integrated storage owner wants to ensure that the storage system will be flexible to both current and future needs. They also need to justify the storage investment as a used and useful resource. No longer just an interesting technology, it can now be viewed as an asset that can be dispatched to its highest and best use as part of ongoing utility operations. As both utilities and regulatory bodies get more comfortable with this new technology, the utility-integrated segment is set to grow significantly.

What are the signs that this is happening? The New York Public Service Commission provided evidence of this trend in an order released on their Reforming the Energy Vision (REV) plan in March 2017.

“The Utilities should be striving to develop their abilities to plan and use energy storage as part of their normal course of business. Utility ownership of DER [Distributed Energy Resources] contemplated here, where energy storage will be integrated into distribution grid architecture, is a permissible exception to the basic presumption that utility ownership of DER conflicts with REV’s underlying tenet that competitive markets and risk-based capital should fund asset development.”

-New York Public Service Commission ORDER 16-M-0411

More and more, utility-integrated storage projects are focusing on solving utility problems, not just demonstrating technology. Within the utility, the project owner is increasingly the operations group in conjunction with the advanced technology group. Warranties are now measured in decades

and supplied by companies with the staying power to credibly offer those assurances. Funding for ESSs is starting to come from utilities’ integrated resource plans (IRPs) as part of an overall system strategy, rather than coming from a special projects silo. This can be seen with Arizona Public Service’s announcement to procure 503 MW of storage through their IRP by 2032. Other evidence for this advancing trend can be found in GTM Research’s Energy Storage tracker. Published in 2Q-2017, this report showed that roughly two thirds of the commissioned systems year-to-date were for utility owners and sized at 2MW or less of power which is ideal for use at substations or elsewhere on the distribution system.

As this utility-integrated wave builds, systems will be dominated by standardized, component-based designs, procurement will become routine, and deployments will grow by orders of magnitude. Utilities will know exactly when and where to consider deploying storage and projects will no longer be “one-offs.” Steve Klein, former General Manager of Snohomish Public Utility District (PUD), succinctly articulated the goal: “Buying and deploying energy storage needs to be as straightforward as buying and deploying transformers is today.”

The third wave of energy storage growth and maturity is here. This utility-integrated wave is marked by a focus on solving grid problems, automatic dispatch of systems in tight coordination with distribution operations, a standards-based software architecture, and a focus on programs versus projects.

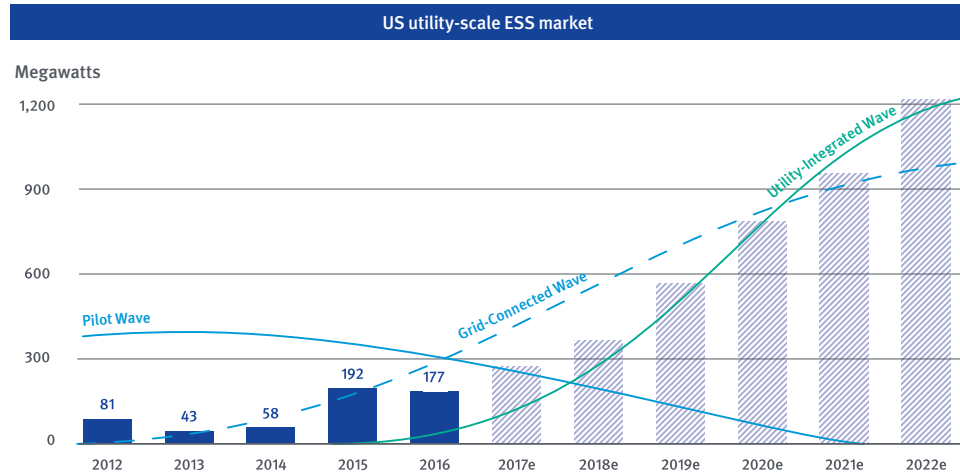

Source: Greentech Media: *Energy Storage Monitor Report Q2-2017*; with wave analysis additionally provided by Doosan GridTech.

Fully realizing the potential of utility-integrated storage requires focus from both the industry producing these systems and from the utility owners buying them. On the industry or supplier side, the imperative is to continue engineering the technology for adoption at scale. Doing this is critical to ensuring that costs continue to fall rapidly and that utilities can confidently purchase the technology in high volumes for mission-critical purposes because they know the products are designed to limit supplier and technology risk.

Utilities also have an important task in enabling the scale up of utility-integrated storage. Their key task is to shift their mindset to take a program-based, rather than a project-based, approach to adopting the technology. Making this shift to a longer-term, more systematic mindset will reduce the likelihood of dead ends or regretted investments. It will naturally highlight issues like fleet management and software architecture that ensure that the whole over time will be greater than the sum of the parts.

INDUSTRY IMPERATIVE: ENERGY STORAGE MUST BE ENGINEERED FOR SCALE TO ACCELERATE ADOPTION AND MITIGATE RISK

Key Points:

1. To both improve performance through continued innovation and drive down costs through economies of scale, the industry needs to clearly identify innovation and standardization zones inside of an overall ESS.
2. These zones should be bounded by open standards-based software interfaces to mitigate supplier and technology risk for utilities as well as lower software integration and training costs.

Engineering energy storage for adoption at scale has two key components: open standards and standardization. A deliberate, industry-wide focus is required to examine the system design and identify the critical innovation zones where rapid performance gains are both desirable and possible. It is also important to wrap those zones with open standards-based interfaces. It is within these innovation zones that new capabilities are developed that improve performance and make the overall product more valuable to owners. Outside the innovation zones, there must be an unwavering focus on consistency and stability to drive volume, reduce costs, manage risk and improve safety.

Publicly available, consensus-based, standardized interfaces ensure that rapid innovation zone progress can be readily incorporated into existing systems at a reasonable cost. And this architecture ensures that utilities can select new components that arise as innovation drives progress – without having to redesign their entire system.

An easy way to visualize these zones is to look at a much simpler product from the electricity system – the light bulb. As shown in **Figure 3**, a light bulb can be understood as having two fundamental zones. The innovation zone which is the bulb and its contents, and the standardization zone which is the base that screws into a fixture. Since Edison’s time, the light bulb has continually evolved through many incandescent technologies, then on to compact fluorescent, and recently reaching light emitting diodes (LED). **The metal base provides value by staying stable so that interoperability is maximized** – and this standardization zone is where offerings become a commodity and costs can be driven down over very large production volumes.

Figure 3. Engineering for scale requires separating a product or system into innovation zones and standardization zones, as shown in the light bulb example here. Innovation zones remain proprietary, and there is intense focus on improving price/performance. In the standardization zones, the focus is on sameness to drive volumes up and costs down.

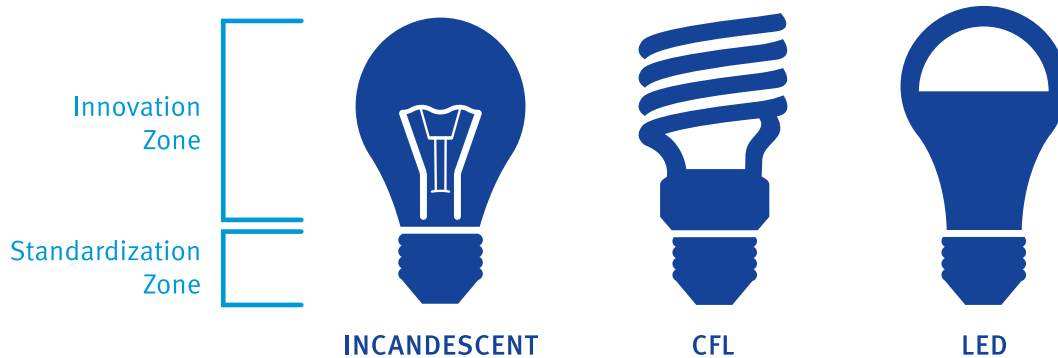

An ESS is far more complicated than a light bulb, but the principles around innovation and standardization zones remain the same. There are physical, electrical and software elements that all must be connected during the installing and commissioning of a system. Batteries, power conversion systems, and control software are all great examples of innovation zones inside of an ESS (*see Figure 4*). Two examples of standardization zones are power meters and transformers. In power meters, the focus is on standardizing ESS design to eliminate redundant meters. In transformers, IEEE and others are working to standardize the way ESS PCSs connect into the transformer so that designs are more uniform.

Figure 4. With current ESSs, rapid innovations are occurring in the battery cell, power conversion system and control software components. Meanwhile, the MESA open-standard communications interfaces allow utilities and suppliers to mix and match technologies to best meet their needs.

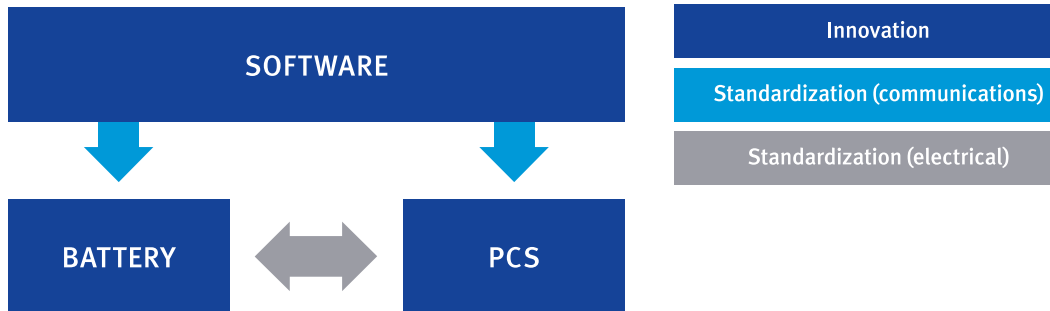

It will take more time for the industry to delineate exactly where the innovation zones end and the standardization zones begin across each of these dimensions. However, the faster the energy storage industry sorts that out, the faster system costs will decline and then adoption will accelerate. This delineation has already started with energy storage software through an organization called the Modular Energy Storage Architecture Alliance (www.mesastandards.org).

WHAT ARE SOFTWARE OPEN STANDARDS AND WHY ARE THEY IMPORTANT TO ENGINEERING FOR SCALE?

To understand why software open standards are crucial for the success of utility-integrated ESSs, it is important to define exactly what the term means. “Software open standards” are specifications that define how information is stored or communicated between different software programs running as part of a larger system. The “open” part refers to the fact that the specifications are available free of charge to any interested party and participation in their development is open to anyone willing to meet the conditions set by the group. The “standards” part refers to the fact that the specifications are developed and refined through a process involving a wide variety of participants (including utilities in some cases) who then commit to requiring or requesting them in procurements as project owners or implementing them in their products as suppliers. The belief from the participants is in the need for broad interoperability and the value of customer choice among the various components that make up the system.

The existence of software open standards in the energy storage market is crucial to the success of utility-integrated storage owners for three main reasons:

1. Software open standards lower technology and supplier risk by preserving choice

Consider a utility who purchases their first ESS and selects a lithium-ion battery from ACME batteries. A few years later, that utility is ready to add more storage to their system, but the use case for this second system is better satisfied by a different type of battery technology. Can the utility buy the new battery technology and still use the existing software control system and/or PCS? What if the utility’s original ESS supplier does not support the new battery technology? If the utility had insisted at the time of purchase that ACME’s lithium-ion system be based on open standards, the chances would be much higher that a supplier of the new battery technology would be able to connect it with the existing control system and/or PCS. Allowing those parts of the fleet or program to remain stable keeps costs down, while taking advantage of the superior price/performance offered by the new battery technology. This is even more true when it comes to choosing between different suppliers of the same technology. Prioritizing support for open standards makes it easier for the utility to change suppliers if the original supplier goes out of business or becomes uncompetitive.

2. Software open standards reduce engineering costs for everyone

Installing an ESS and integrating it with grid operations requires that several different software programs from different suppliers “talk to” each other. In a poorly coordinated industry with no open standard interfaces, the project-specific process of “stitching” is unique to each pair of suppliers who are connecting their software. And that uniqueness comes at a price. Project owners pay for stitching work as part of their overall project cost. Open standards take away much of the need for customized project stitching by defining it for the entire industry of suppliers. In general, projects using open standards will require much less custom stitching work compared with projects using the same components but not using open standards (see Figure 5). Some suppliers will say they lower this cost for owners by pre-engineering interfaces between their software and all the options out in the market, but owners should be wary of this claim. This claim requires that the supplier keep up with all the innovations in the entire industry, even ones they do not currently sell, and absorb the cost of maintaining that stitching without passing it along to their customers.

Figure 5. Open standards minimize the custom engineering expenses in energy storage projects and programs.

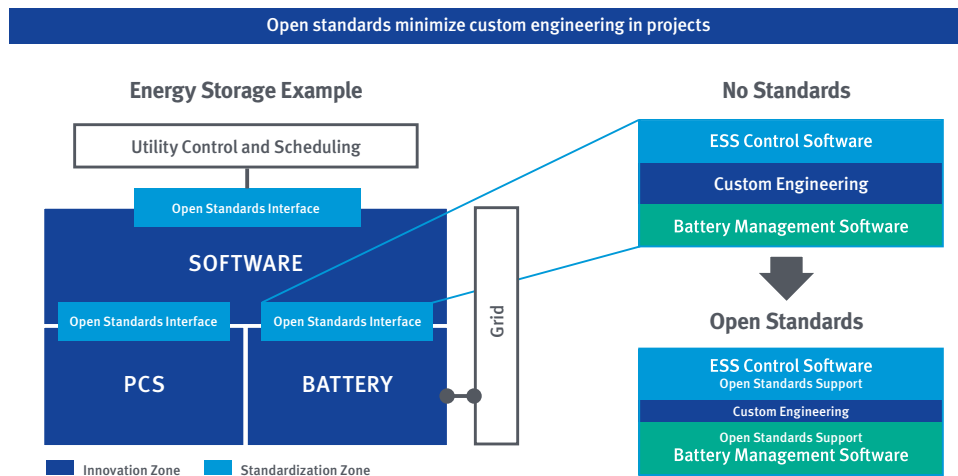

3. Open standards and standardization improve safety by reducing complexity which simplifies training

The essence of engineering for scale is being thoughtful about the parts of a product or solution where innovation is truly valuable and being relentless about standardization everywhere else. Standardization simplifies engineering of a multi-part system because designs can rely on certain components staying the same. And the more things are the same, the easier it is to train personnel on how to operate, maintain, troubleshoot and repair the overall system. This is valuable in every industry, but perhaps particularly in the electricity system where mistakes can carry safety costs in addition to financial costs.

For the reasons listed above, offering a software architecture built on open standards interfaces and engineering for scale more broadly, is vital for new industries and technologies aspiring to have broad impact on the world. Most products and industries with those characteristics have traveled the open standard path – industries from light bulbs to automobiles to telecom and computing infrastructure. The energy storage industry has begun this journey, particularly in the software elements, and must complete the task for the technology to achieve its full potential.

UTILITY IMPERATIVE: APPROACH ENERGY STORAGE AS A PROGRAM, NOT JUST A PROJECT

Key Points:

1. Utilities can best balance cost and risk by taking a program-based, rather than a project-based, approach to adopting energy storage
2. Key elements of a program-based approach include:
 - Begin with the end in mind – understand clearly at the start what specific grid problems or opportunities the ESS (and program) will address
 - Think through the software architecture upfront – it needs to envision a fleet of storage, not just a single system, enable tight integration with existing distribution operations and preserve flexibility to address a range of battery chemistries and hardware technologies over time.
 - Organize for success – energy storage, by its nature, spans traditional boundaries. The project team composition should reflect that fact.
 - Manage cost and risk in procurement – carefully analyzing the stages of energy storage procurement will yield opportunities to better manage cost and risk over time.

The previous sections have discussed the industry side of the storage opportunity, but what about the storage owner side? For utilities, the path to best use of ESSs comes through taking a program approach, not a project approach, to adoption.

A PROGRAM APPROACH HAS FOUR KEY CONCEPTS

First: *The lowest risk, highest reward outcomes happen when utilities take a “begin with the end in mind” approach.* What are the specific grid problems or opportunities that are highest priority? Are those well understood at both an economic and engineering level? Does the end game involve a fleet

of ESSs or just a single system? The more time a utility spends on upfront thinking about what the goals are for the proposed ESS program, the less likely a utility will be to find their expansion limited or be stuck with stranded assets down the road.

Second: *Think through the software architecture.* Grid-connected ESSs are a straightforward software problem. The control software task is to respond to a charge/discharge signal often dictated by an ISO signal or AGC command. But when the endgame is an entire fleet of ESSs and includes systems from different suppliers and featuring different chemistries, the choice of software controls is substantially more important (see Figure 6).

Figure 6. Snohomish PUD contemplated software architecture at the beginning of their energy storage program before evaluating any hardware. The PUD installed an open standards-based software platform to control and optimize a fleet of ESSs with the overall goal of meeting all future load growth without the addition of any fossil fuel generation.

Snohomish PUD’s “MESA” Energy Program

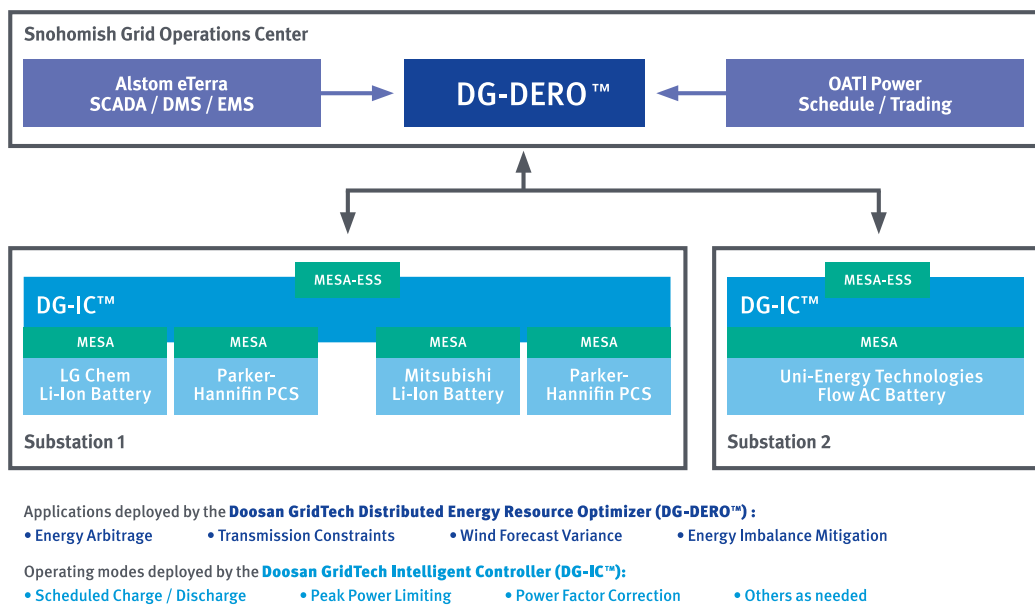

For utility-integrated energy storage to deliver its full value to an owner, the control software needs to orchestrate the fleet to perform multiple, simultaneous tasks:

- dispatch both real and reactive power;
- factor in local circuit conditions and bulk power system opportunities; and,
- coordinate with the SCADA and DMS software that controls the overall distribution system.

The utility-integrated software control platform must run on open standards to ensure the broadest interoperability with different suppliers and different technologies. The system requires intelligence at both the local and central control levels because it is at the local level that the response time can be guaranteed and adjustments quickly affected. However, it is at the control center level that fleet-wide considerations and bulk power system opportunities are best evaluated. When each level of intelligence is built so that applications can be quickly developed, precisely configured and dynamically prioritized a software framework exists for rapid innovation that ensures storage resources will have their maximum positive impact.

Third: *Be prepared to bust silos*. One of energy storage’s biggest strengths is also a weakness. As a “superset asset”, energy storage systems can be used to address the full range of real and reactive power needs. The Rocky Mountain Institute translated this capability into the discrete grid services at the generation, transmission and distribution levels of the electricity system shown in **Figure 7**. The challenge of this flexibility and range comes in two areas: 1) determining the most valuable use of the ESS resource at each moment of each day; and 2) working through the organizational barriers to realize that optimal value for the ESS may require the coordination of groups that have historically operated independently.

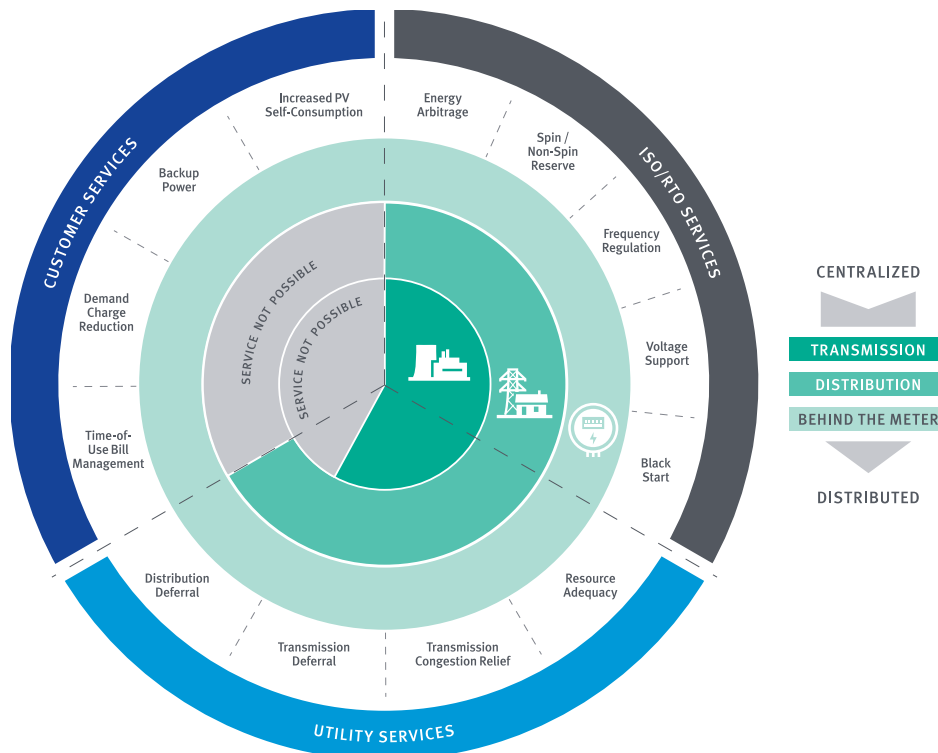

Figure 7. Rocky Mountain Institute's analysis makes clear that realizing storage's full value requires transcending traditional boundaries.

Source: Rocky Mountain Institute: *The economics of energy storage 2015*

Austin Energy understood this and quickly focused their energy storage work into a circuit-oriented distributed resources project with an overarching economic goal to achieve high penetrations of renewable power while maintaining power quality, reliability and affordability. Austin Energy then appointed a cross functional team to include three executive sponsors who could span organizational boundaries to achieve the project goals. At an even larger utility like Duke Energy, their Emerging Technologies group plays a key role in achieving this cross-silo perspective. The energy storage industry will only realize its potential when utilities and regulators follow Austin Energy’s and Duke Energy’s lead and commit to tackling the silo boundaries that inhibit a full valuation of energy storage.

Fourth: *Managing cost and risk during implementation*. Once the broad purpose of the ESS program is settled and the storage owner has explored the full breadth of available sources of value, they are ready to move into the procurement phase. Today, most storage systems are procured on an individual basis from a full-service supplier, often using a long-term power purchase agreement (PPA) which keeps the systems and their operations at arms-length. This is partially due to the perceived delivery risk associated with the system suppliers and comparable performance and safety risks

with the technology. However, this PPA strategy leaves utilities exposed to other long-term risks: use-case obsolescence, interoperability issues, and potentially expensive training, operations and maintenance costs.

In a program approach, the ESS program activities shown in **Figure 8** below are mapped according to their level of uniqueness to the utility and the risk that the activity presents to the overall success of the program. Taken to its logical conclusion, this analysis suggests that component selection, procurement and installation (steps four and five) should be as simple as opening the catalog and buying parts. In the end, this end-state should be possible if the industry engineers for scale. Higher risk activities that are more unique to the individual utility such as a system needs study may benefit from more of an owner’s engineer arrangement. And some activities such as installation and commissioning may be better handled by the utility itself. In the end, the procurement process in an ESS program approach should be deliberately examined with step-by-step methodology to best balance both risk and cost for the utility.

Figure 8. The seven key steps for taking a program approach to energy storage.



CONCLUSION

Energy storage has made important progress toward reaching a third major wave of growth driven by utility-integrated projects. In the industry’s first twenty years, the technology has been validated and has matured as demonstrated by the PJM and Aliso Canyon projects. However, substantial opportunity remains available through full integration of energy storage into distribution systems. These utility-integrated systems will prepare utilities to accommodate the coming wave of distributed solar generation, electric vehicles and other energy resources. Both the energy storage industry and its utility customers have important roles in realizing this potential.

On the industry side, ESS suppliers need to focus on reducing costs and system complexity by engineering storage for adoption at scale. Innovation and standardization zones need to be delineated across the physical, electrical and software elements of the system. In the software area, the open standards work led by the Modular Energy Storage Architecture Alliance (MESA), SunSpec, and OpenADR needs to be continued and adopted by the entire industry of component suppliers.

On the customer side, utilities must engage energy storage in a program, not a project-based, fashion. This will require support and coordination from regulators. To engage energy storage as a program, utilities need to start with a careful analysis of the most important system-wide opportunities and problems which most likely start with the proliferation of solar PV and electric vehicles on the system. After that, utilities should evaluate their need for a system software architecture that can adapt and get smarter as it operates in the field as well as accommodate new generations of technology in each system component area (batteries, PCS, control software). The right control software platform, including support for open standards communications, is perhaps the most crucial aspect of this decision.

At Doosan GridTech®, we believe that enduring economic growth and environmental healing start with a resilient, low-carbon power grid. We are a multi-disciplined team of power system engineers, software developers, and turnkey energy storage specialists. We help utility-scale power producers evaluate, procure, integrate, control, and optimize energy storage, solar power, and other renewable power resources. Our battery storage experts in Seattle, Melbourne, and Seoul have designed and built over 35 installations in the Americas and Asian-Pacific regions – representing over 453MW of capacity.

www.doosangridtech.com

DOOSAN